

Item Description	: Luna Study Table
Model No	: 56007
Dimension	: W: 130 / D: 65 / H: 75
Total Weight of Item	: 64,4 kg

People Required

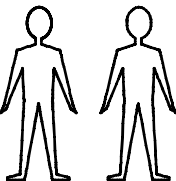

For Professional assembly only

Time Required: 1 hrs. 15 min.

Tools Needed



* Vertical Assembly Only.
* Please cover floor with corrugated board / paper to avoid scratches / damage to floor.

Assembly Checklist

Please make sure that you have all of the below items before you start.

Parts supplied for assembly

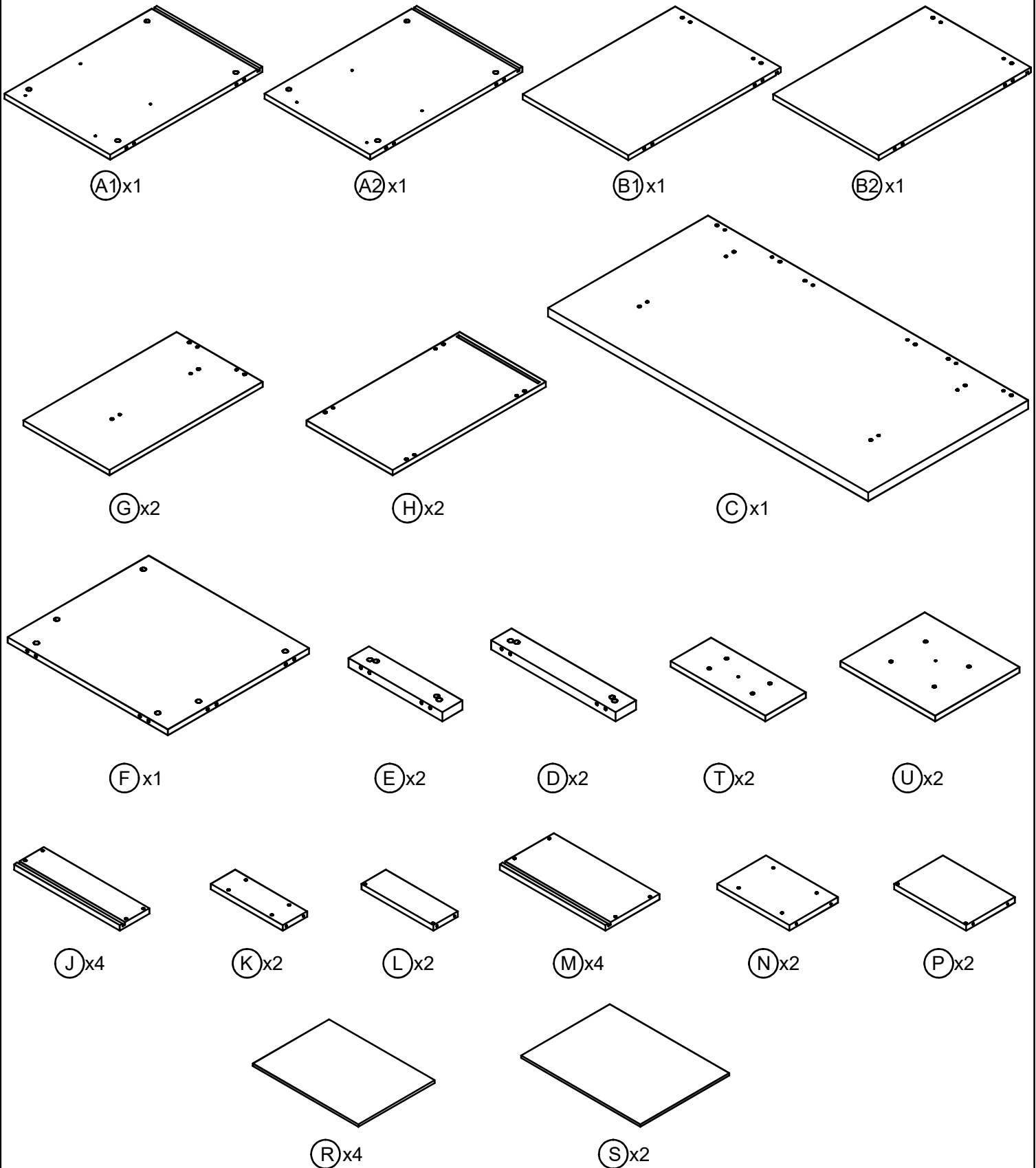

Part List	A1	A2	B1	B2	C	D	E	F	G	H	J	K	L	M	N	P	R	S	T	U
Carton Box No.	1	1	1	1	2	2	2	2	1	1	2	2	2	2	2	2	2	1	2	2

Hardware supplied for assembly

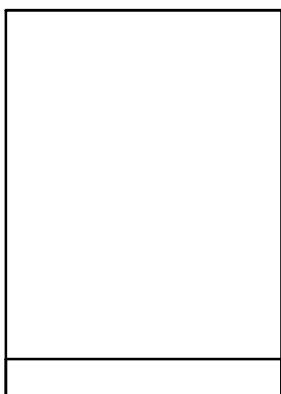
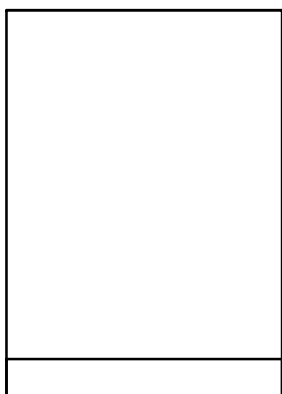
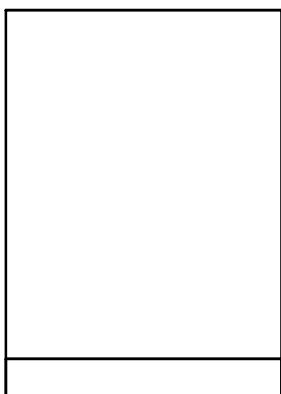
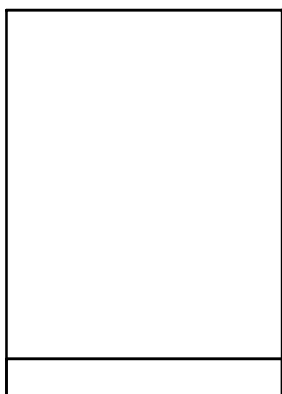
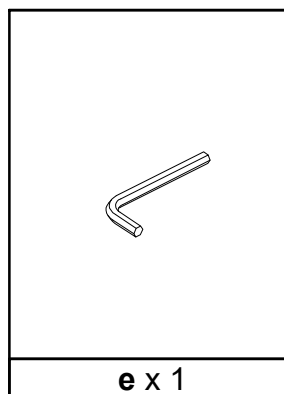
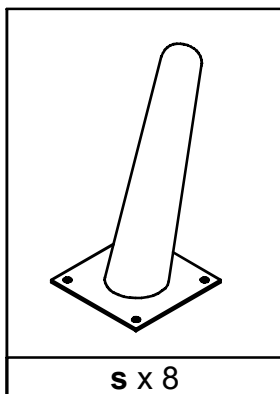
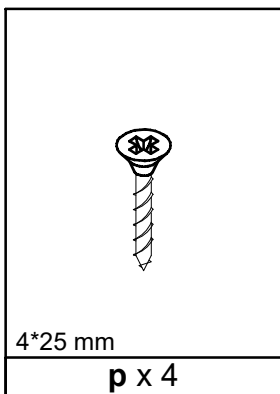
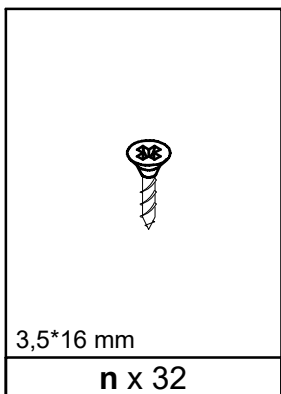
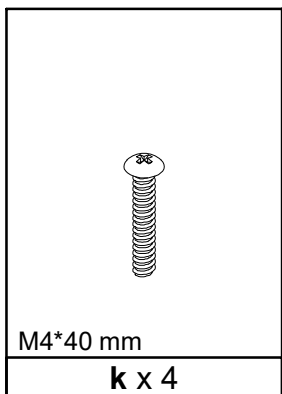
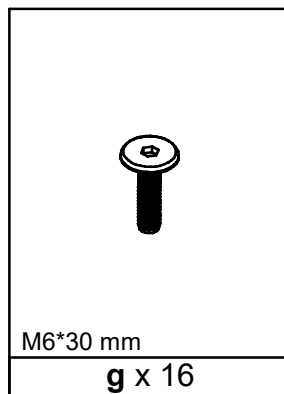
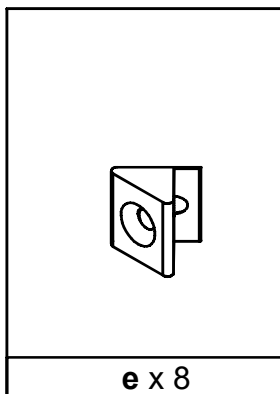
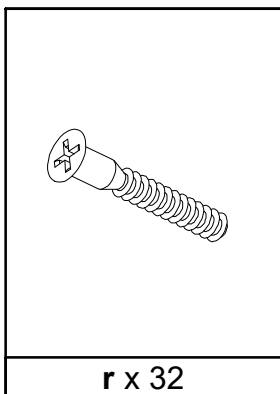
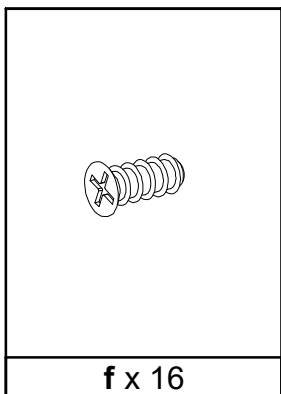
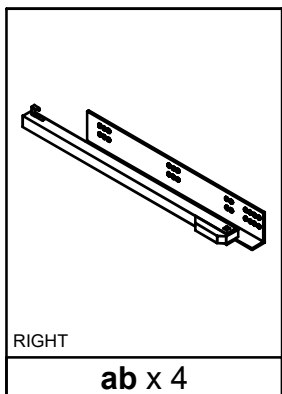
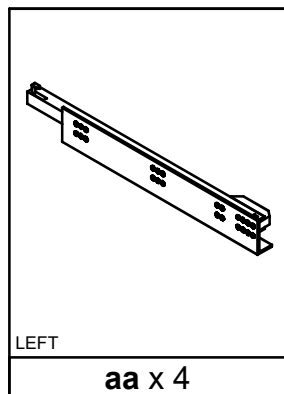
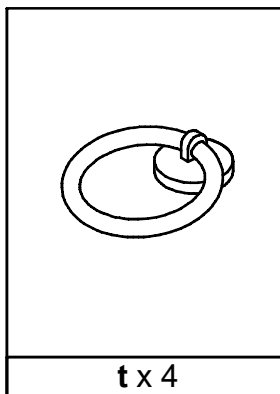
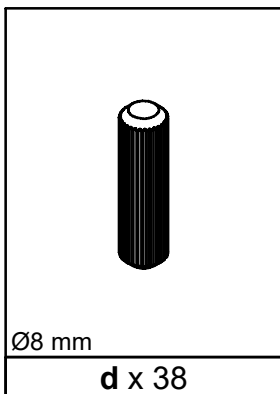
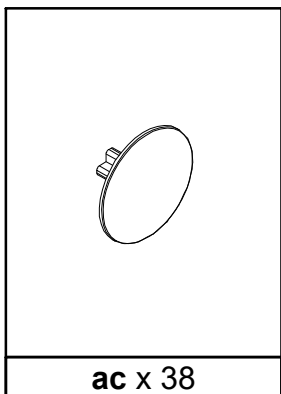
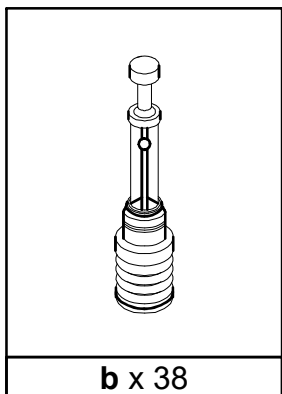
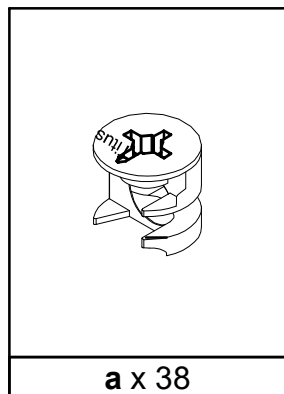

Step 1

Parts

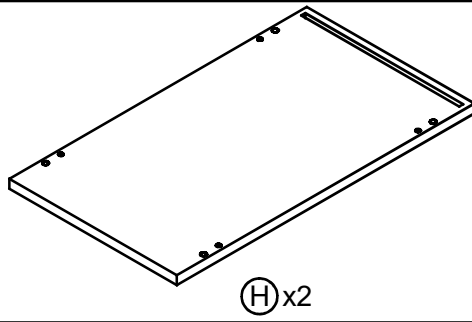

Hardware



(b) x 8



(d) x 8

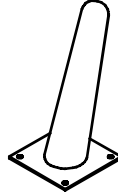

(s) x 8



(n) x 32

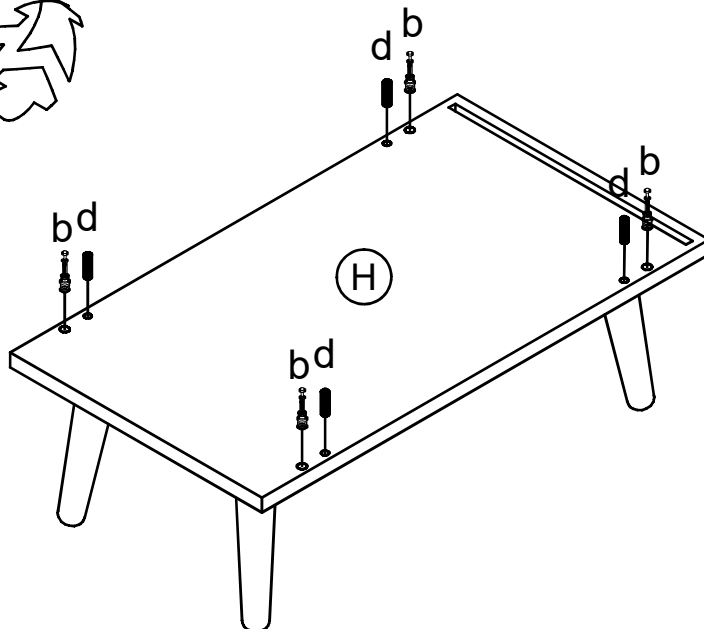
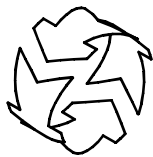
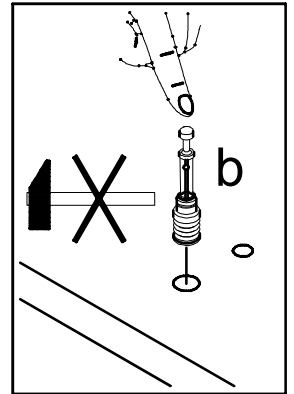
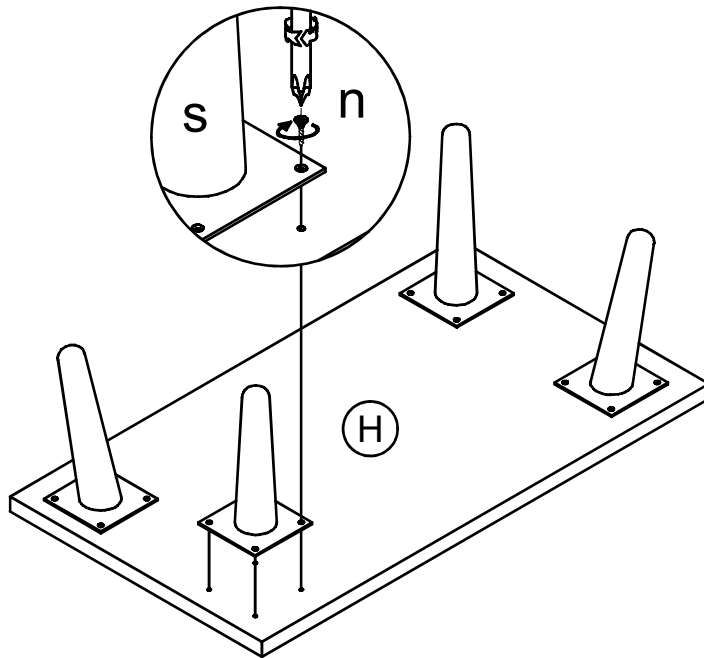

Step 2

Parts

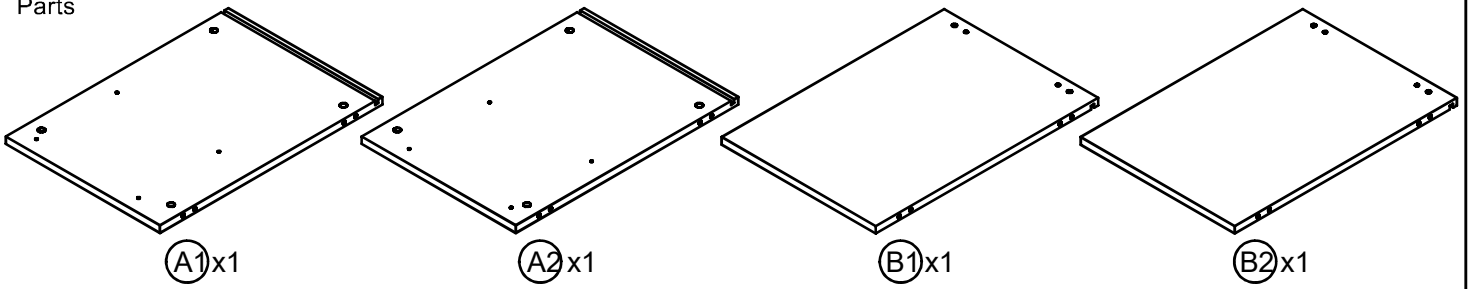

Hardware

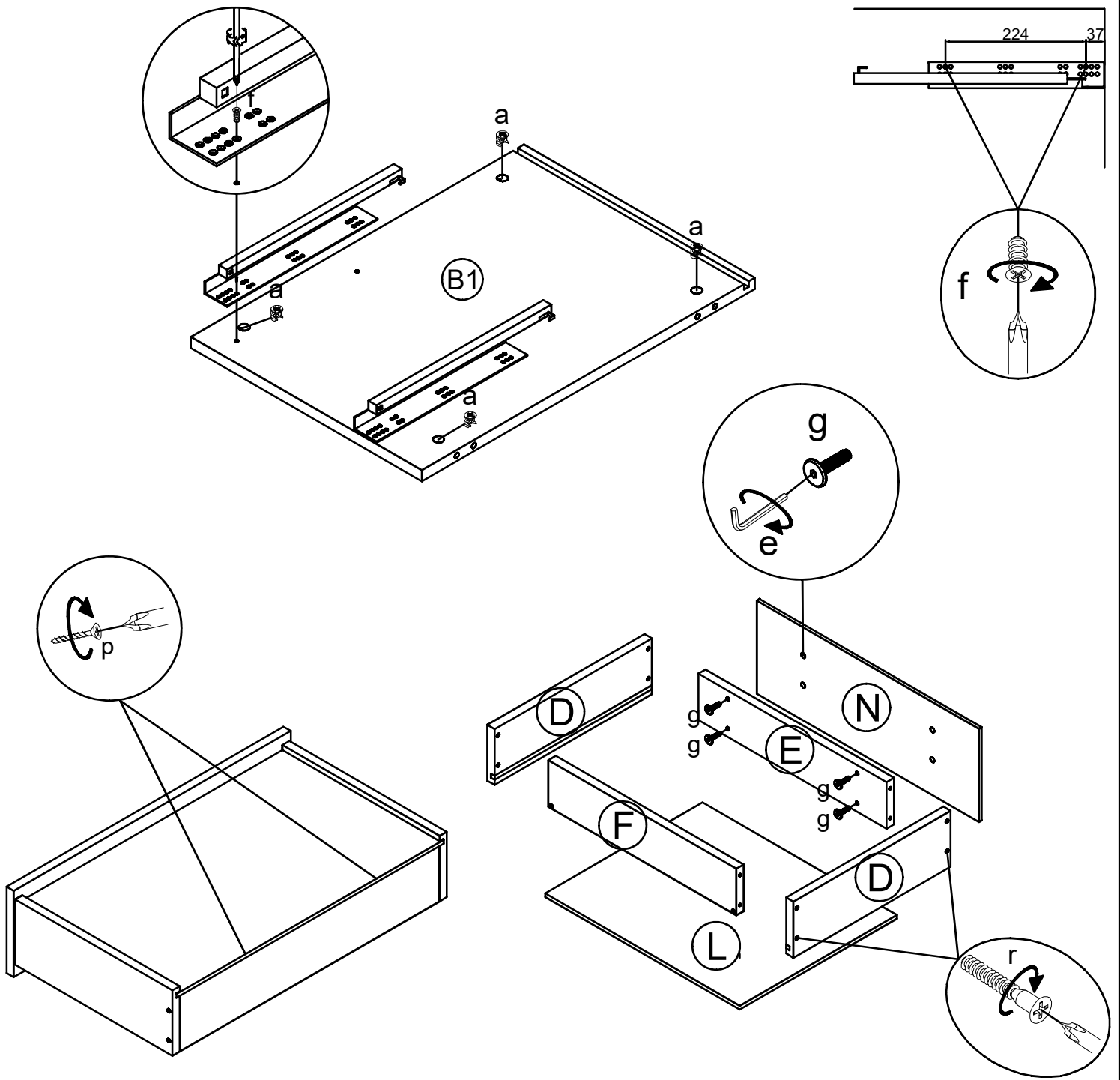
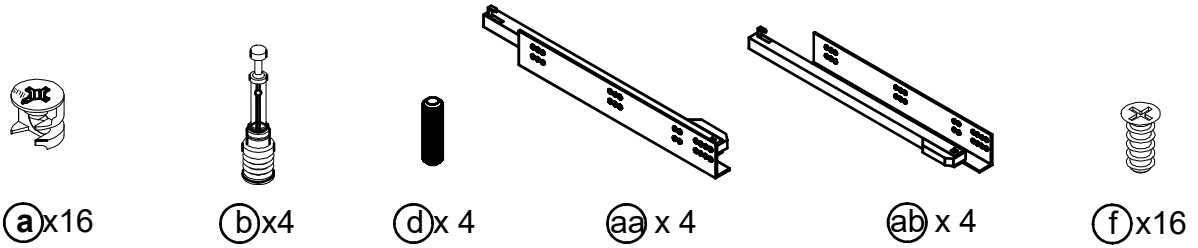

Step 3

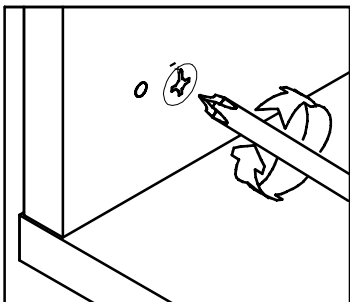
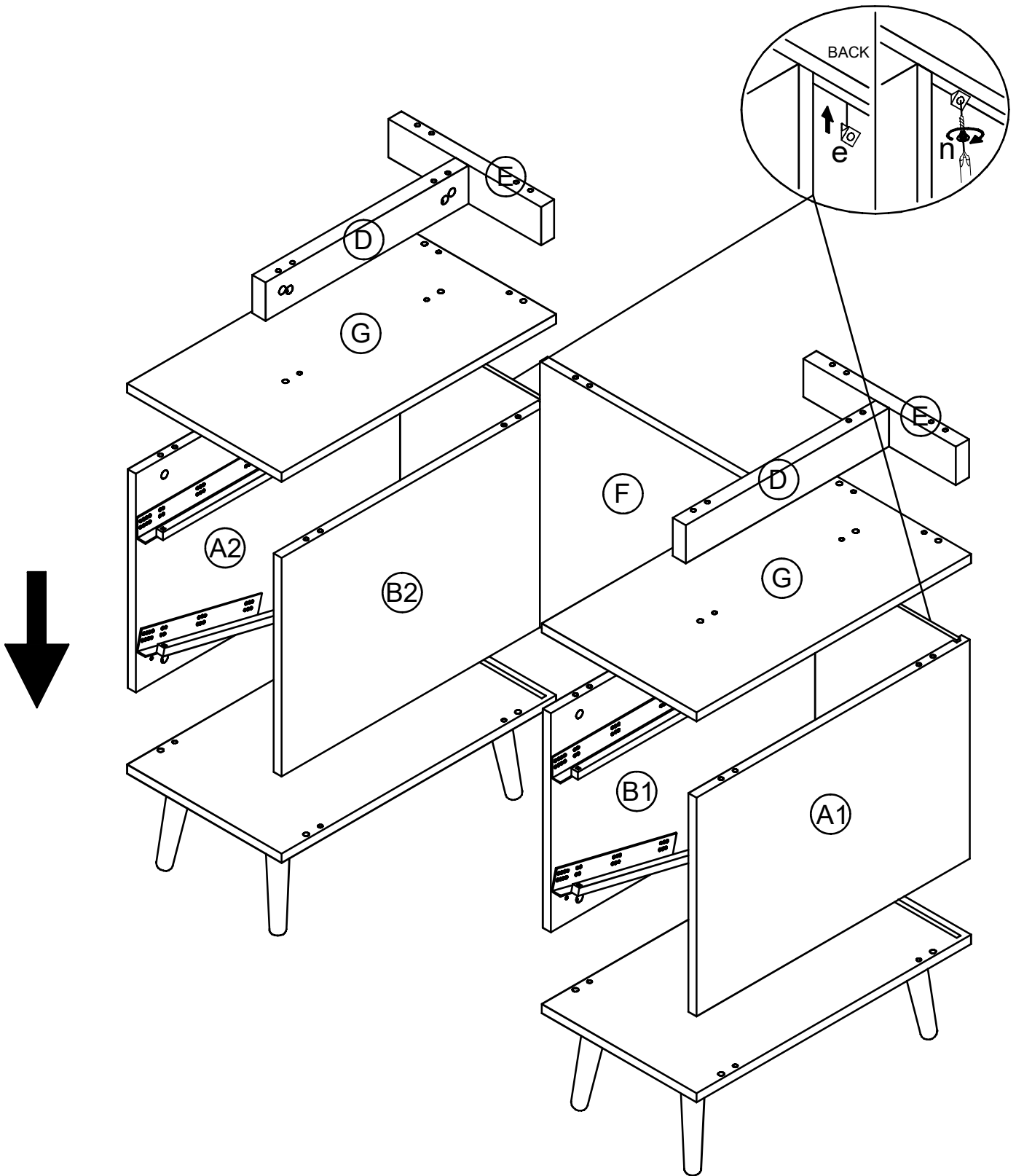

Step 4

