

Item Description : Luna Bookcase
 Model No : 56001
 Dimension : W: 70 / D: 57 / H: 164.4
 Total Weight of Item : 62,29 kg

People Required

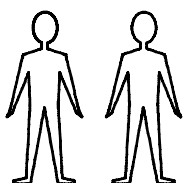

For Professional assembly only

Time Required: 1 hrs. 30 min.

Tools Needed



* Vertical Assembly Only.

* Please cover floor with corrugated board / paper to avoid scratches / damage to floor.

Assembly Checklist

Please make sure that you have all of the below items before you start.

Parts supplied for assembly

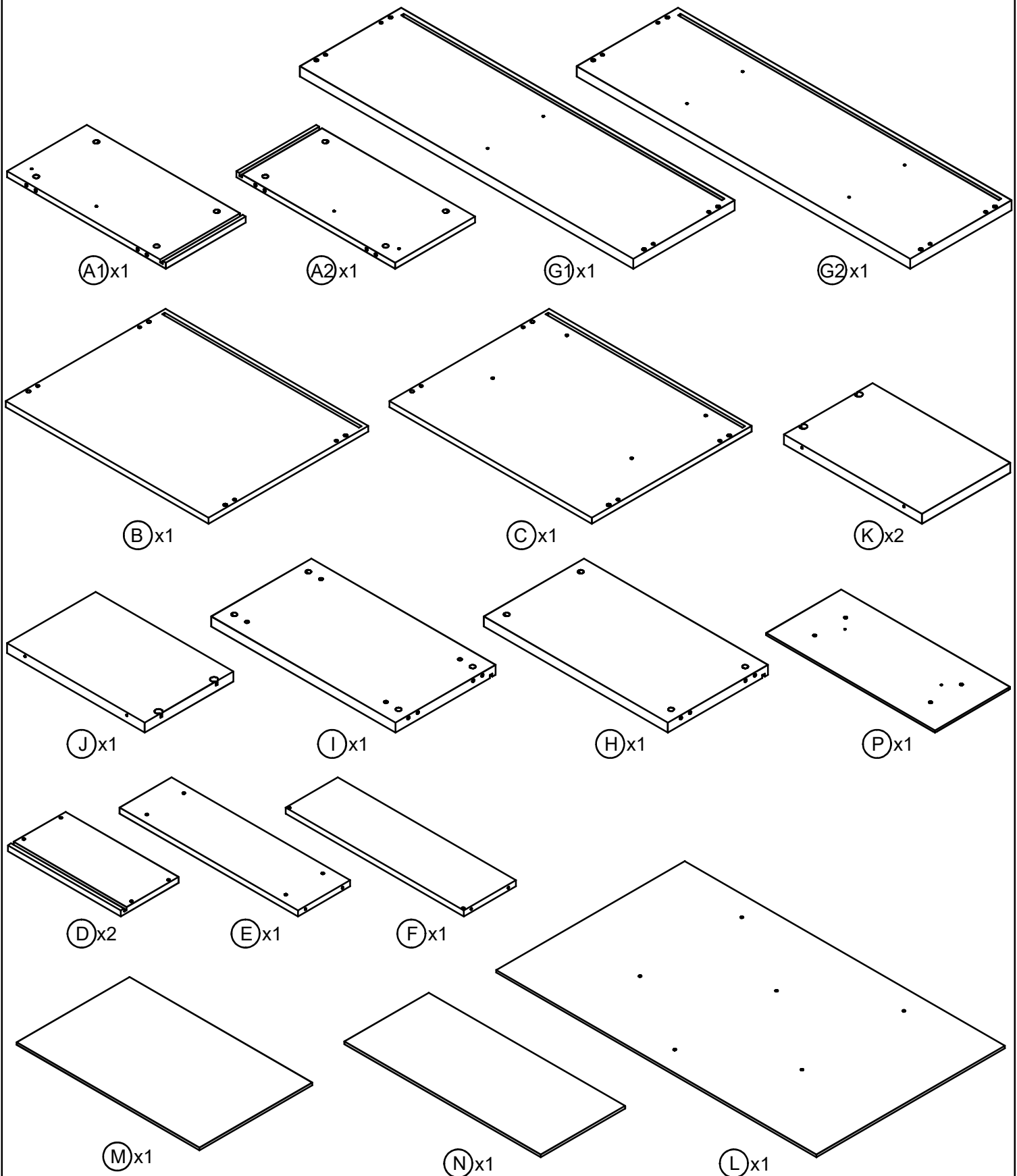

Part List	A1	A2	B	C	D	E1	E2	F1	F2	G	H	J	K	L	M	N	P
Carton Box No.	1	1	1	1	1	1	1	2	2	2	2	2	2	2	1	1	1

Hardware supplied for assembly

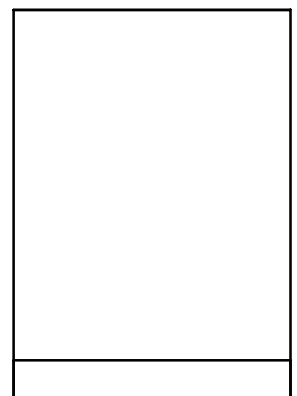
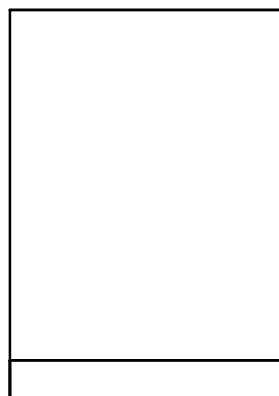
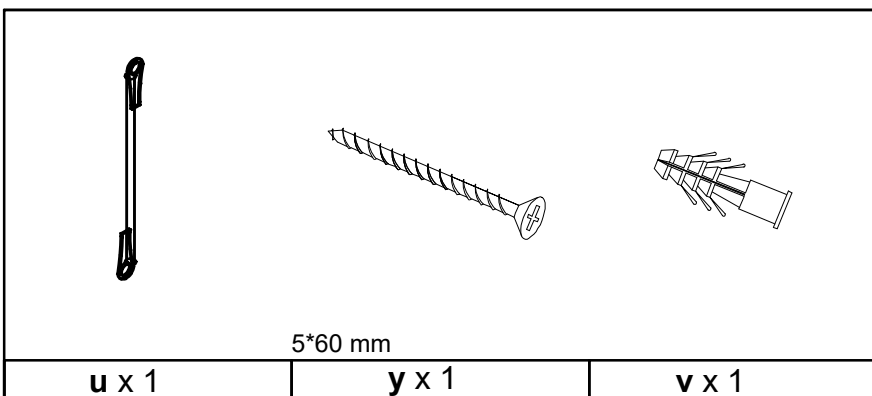
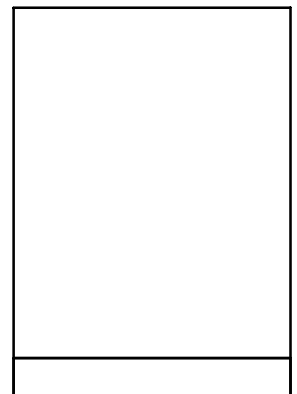
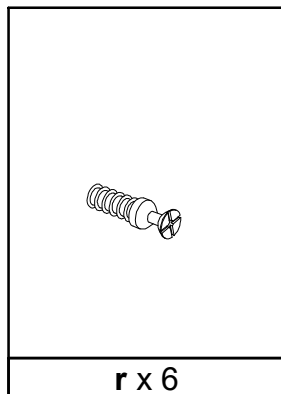
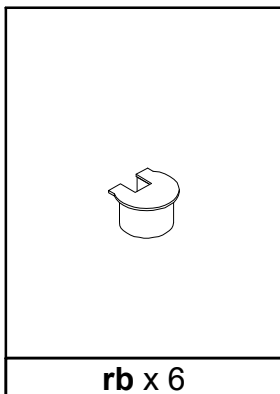
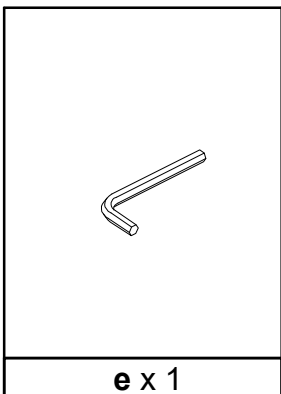
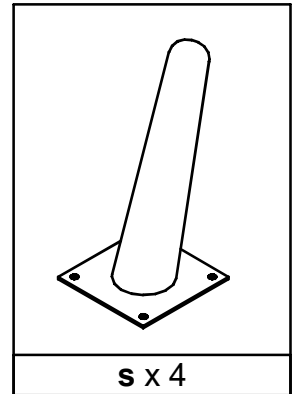
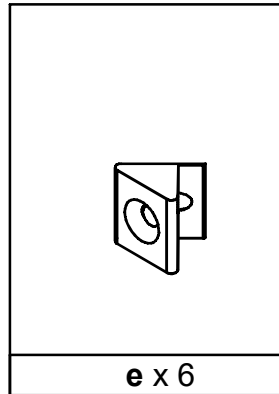
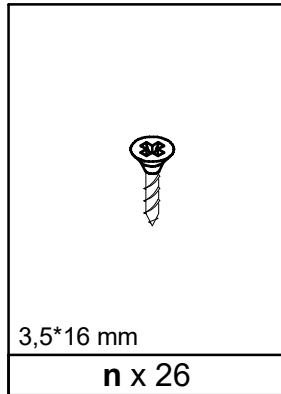
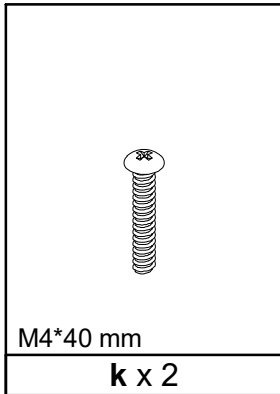
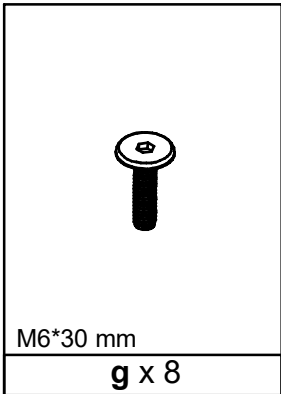
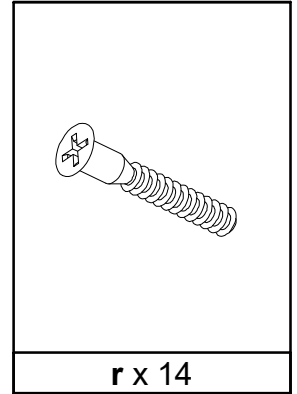
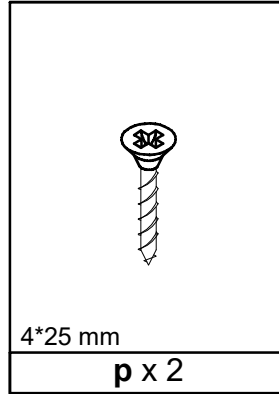
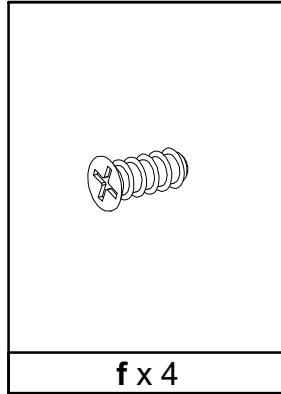
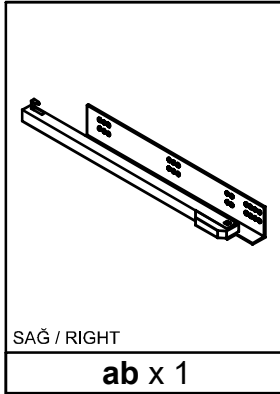
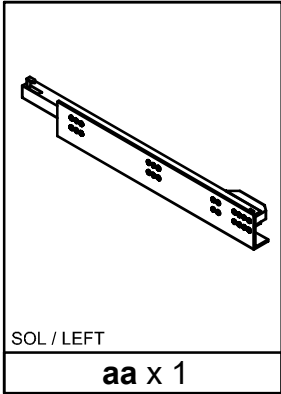
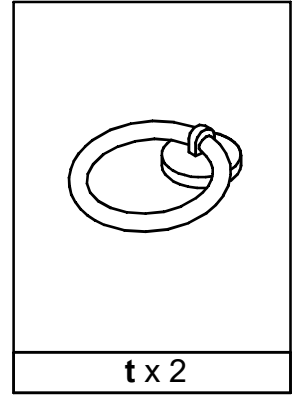
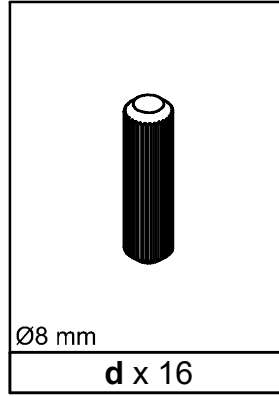
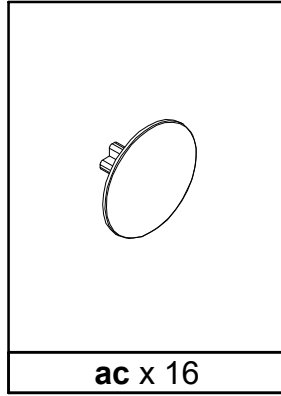
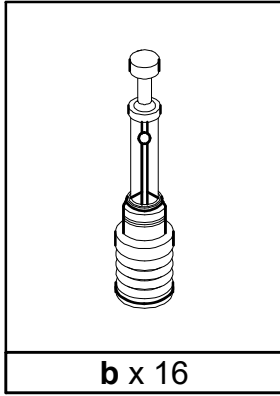
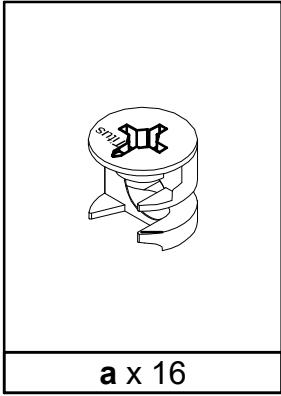

Step 1

Parts

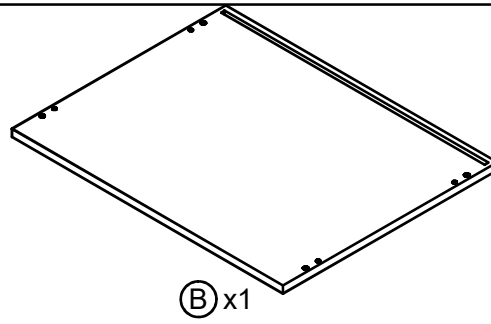

Hardware

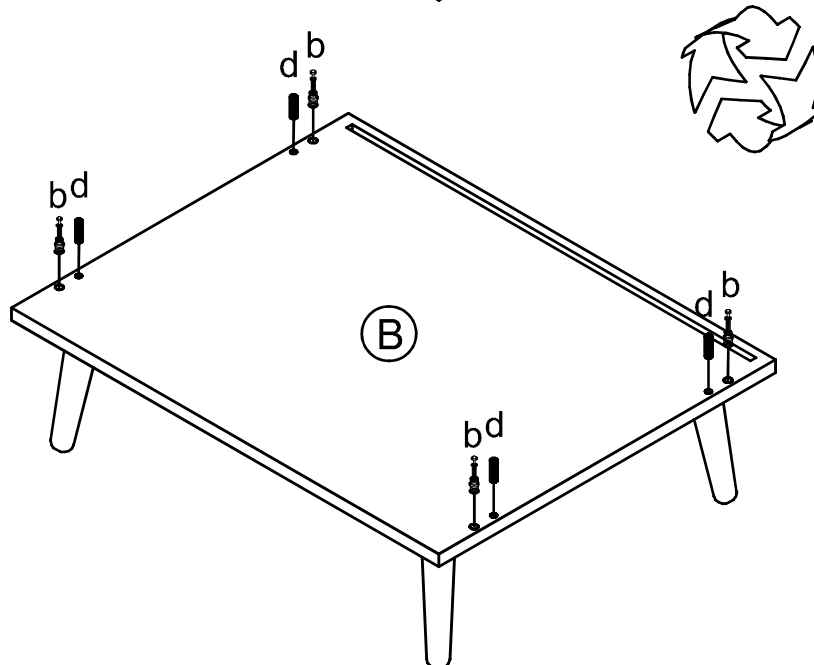
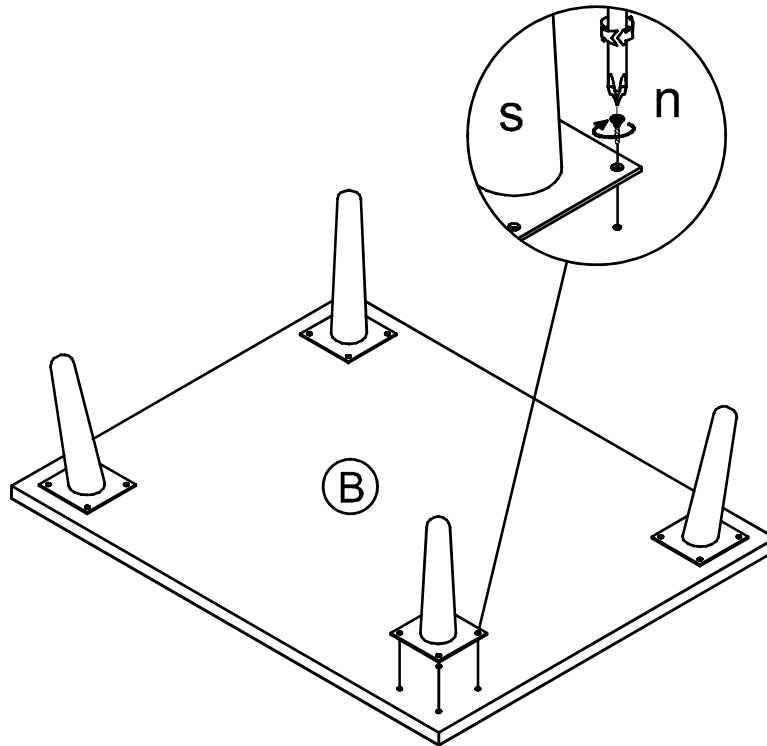
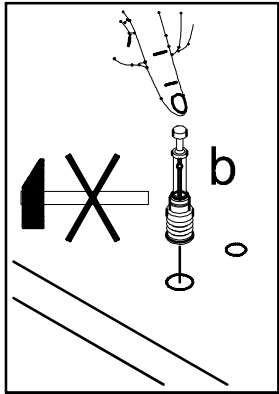
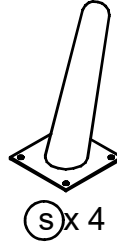
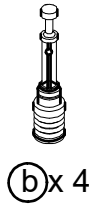

Step 2

Parts

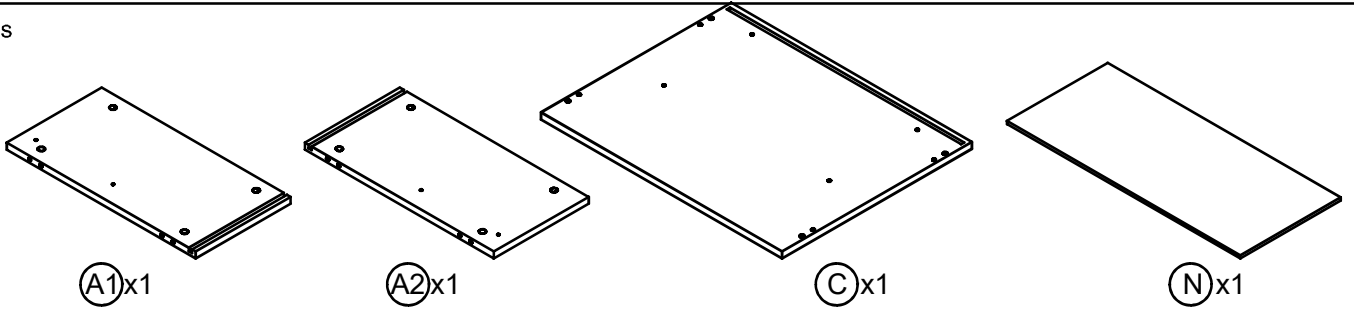

Hardware

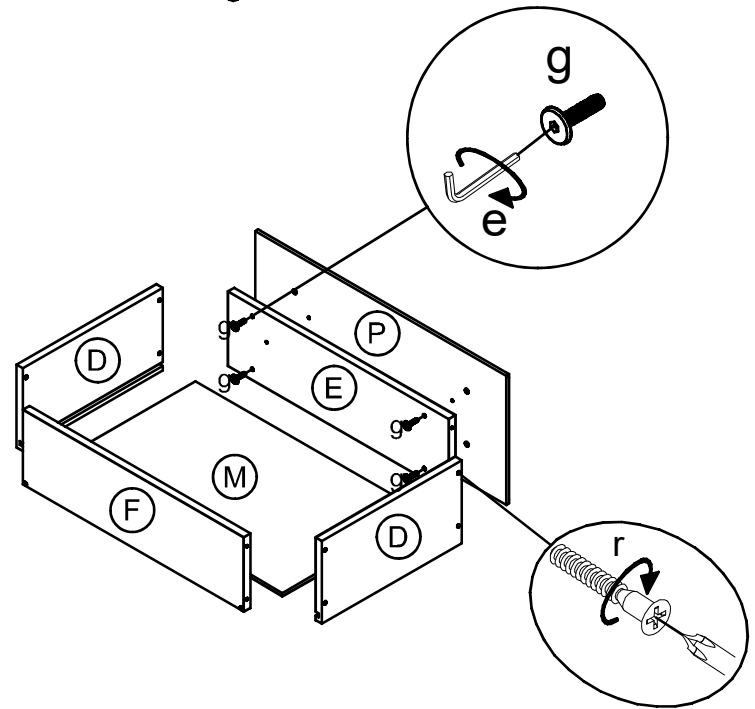
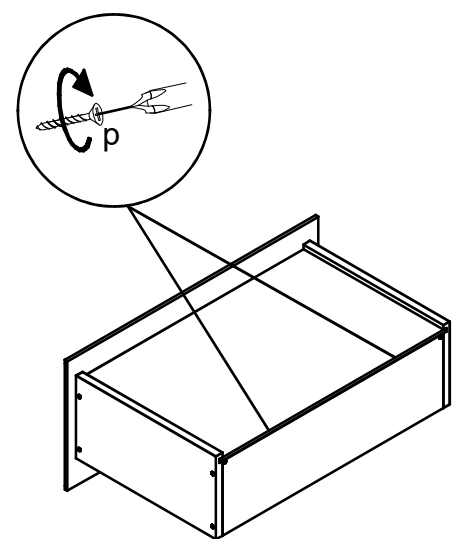
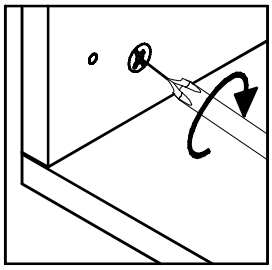
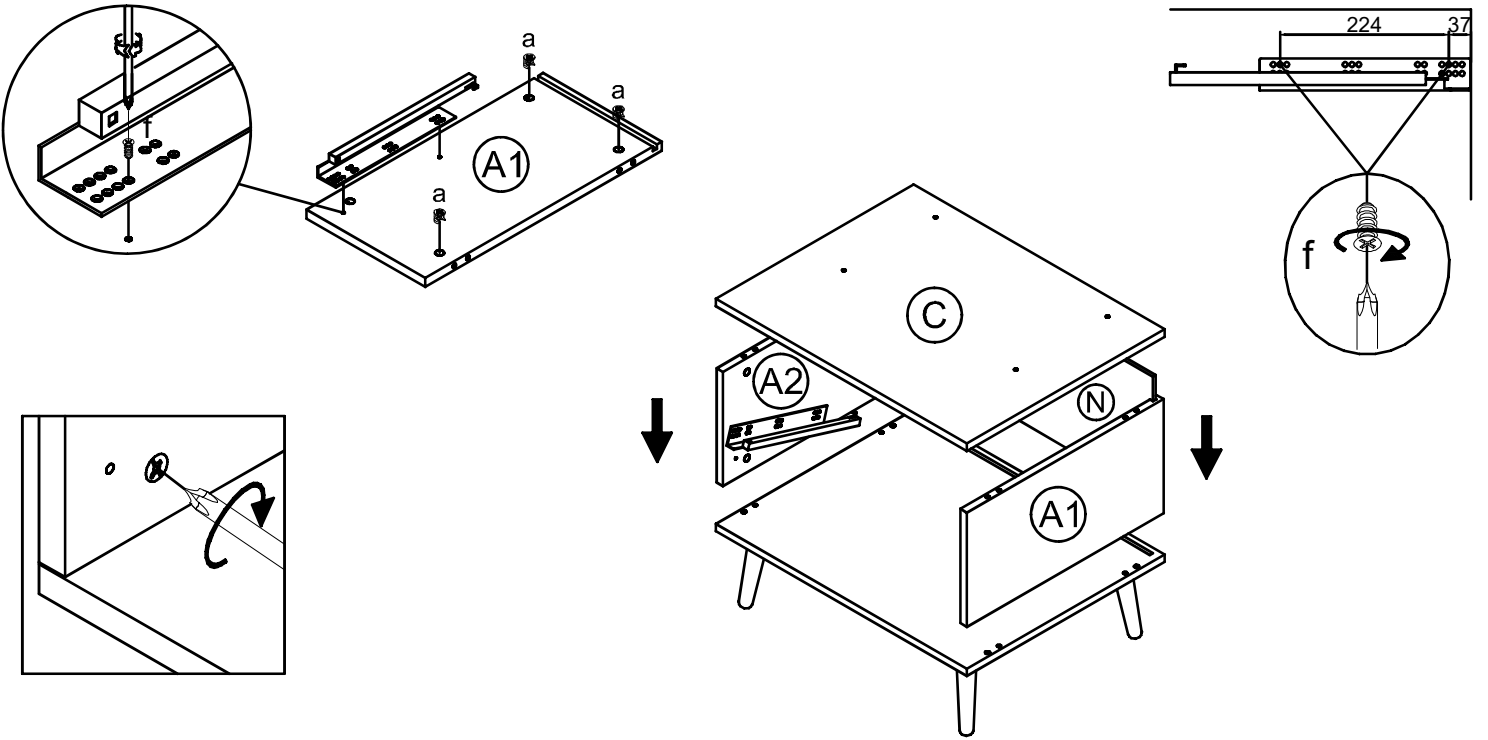
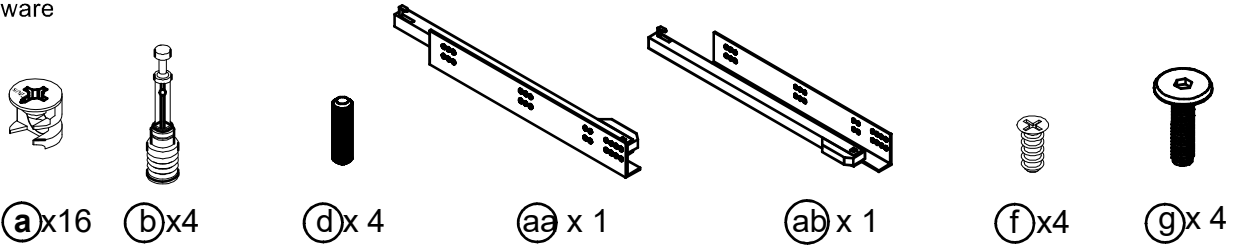

Step 3

Hardware



g x 4



k x 2

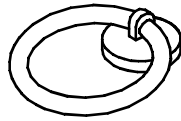

t x 2



ac x 16



rb x 6

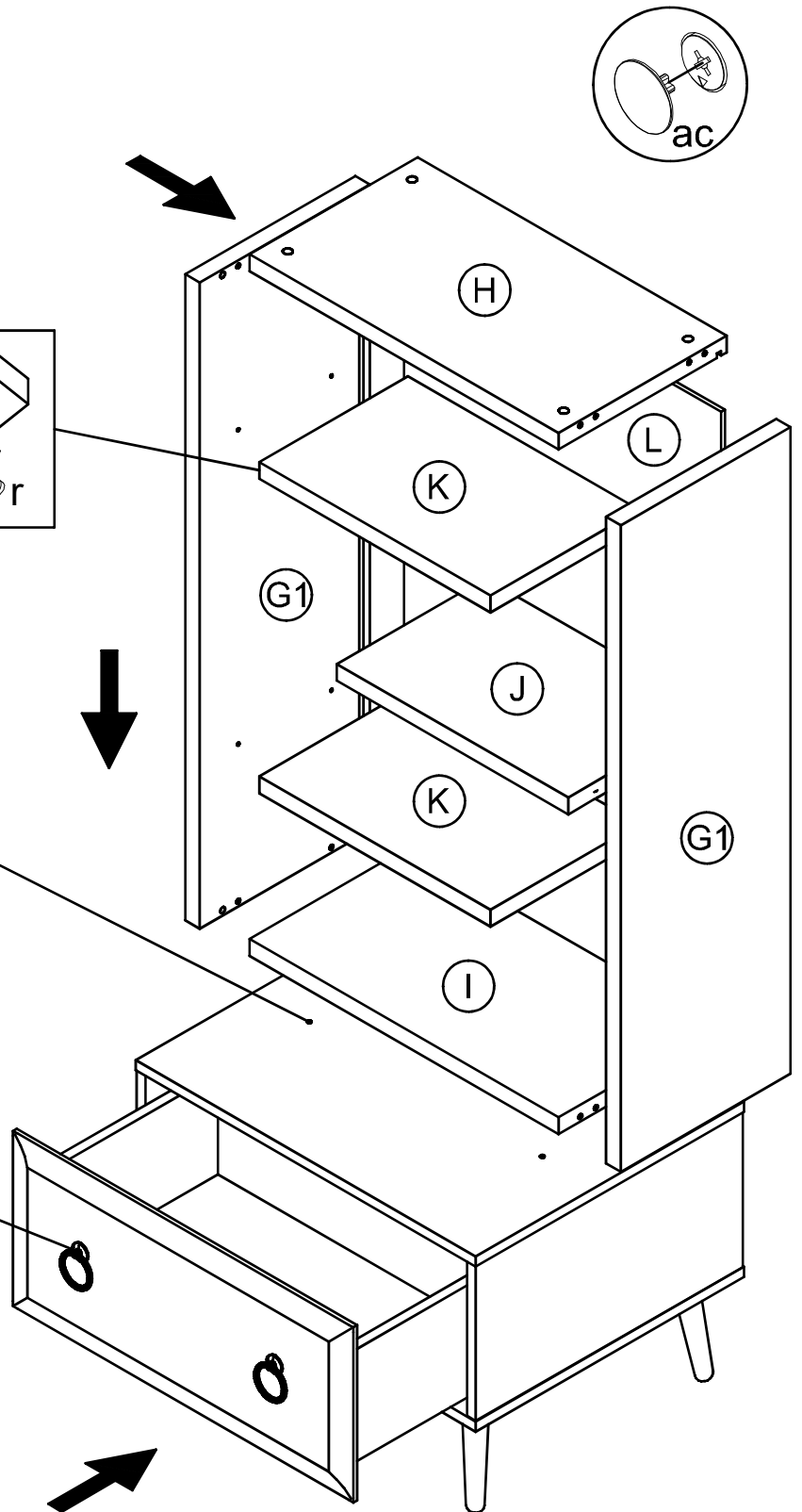
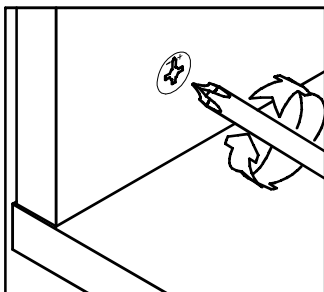
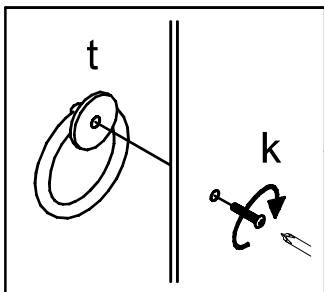
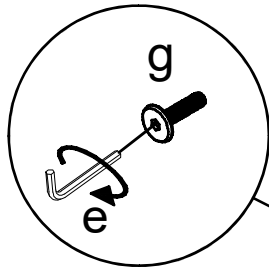
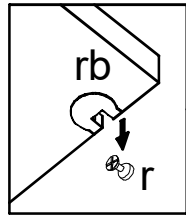
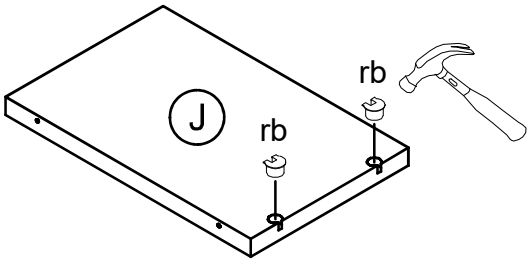

Step 4

Hardware

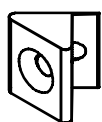

e x 10



n x 10

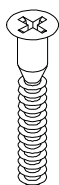

r x 14



p x 1

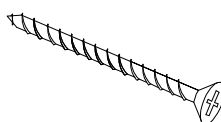

y x 1

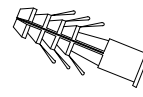

v x 1



u x 1

