

Item Description : Venüs Nightstand  
Model No : 55006  
Dimension : W: 50 / D: 48.2 / H: 42.6  
Total Weight of Item : 18 kg

People Required

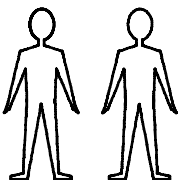

For Professional assembly only

Time Required: 20 min.





Tools Needed



\* Vertical Assembly Only.  
\* Please cover floor with corrugated board / paper to avoid scratches / damage to floor.

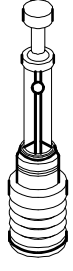
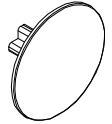
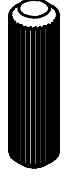
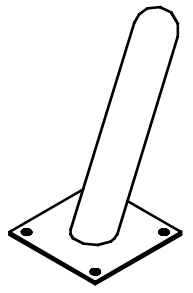
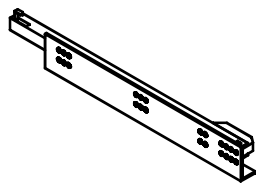
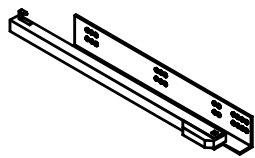

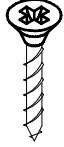
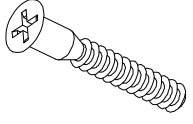
Hardware supplied for assembly

 <b>a x 14</b>	 <b>b x 14</b>	 <b>ac x 14</b>	 <b>d x 8</b>	 <b>s x 4</b>
 SOL / LEFT <b>aa x 1</b>	 SAĞ / RIGHT <b>ab x 1</b>	 <b>f x 4</b>	 4*25 mm <b>p x 2</b>	 <b>r x 10</b>
 3,5*16 mm <b>n x 16</b>				

### Step 1

Parts

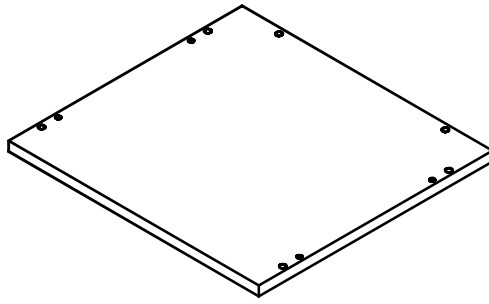

Ⓑ x1

Hardware



ⓑ x6



ⓓ x4



Ⓝ x16

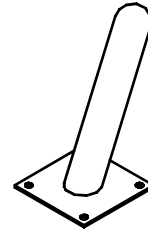

Ⓢ x4

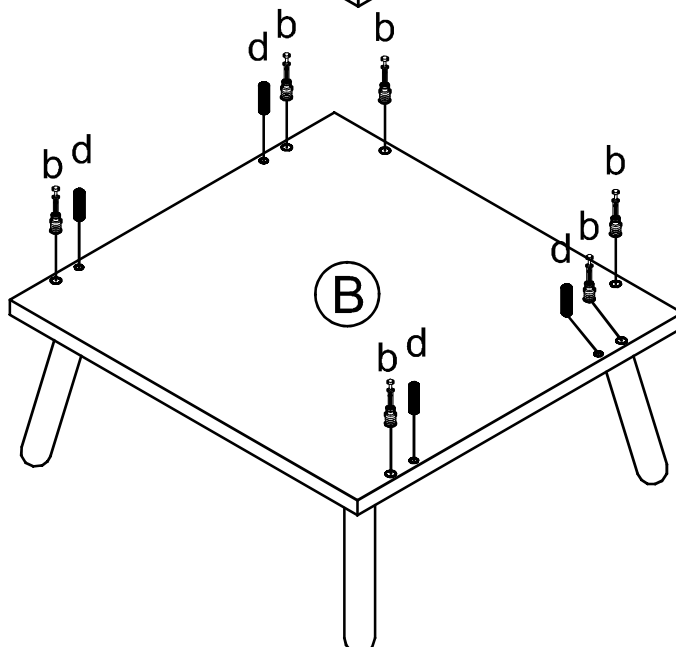
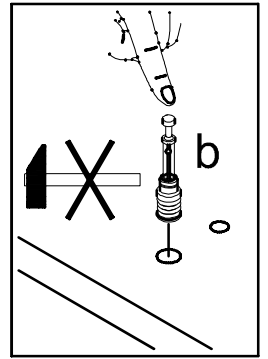
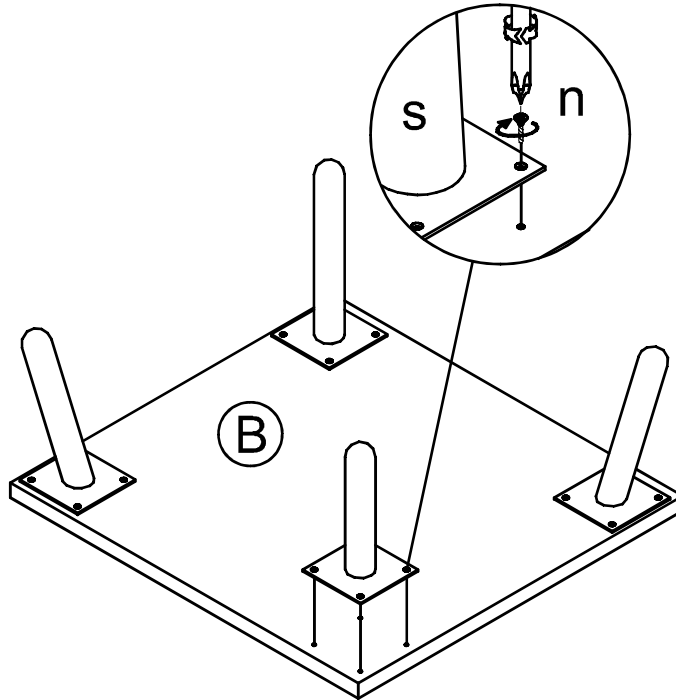

### Step 2

#### Parts

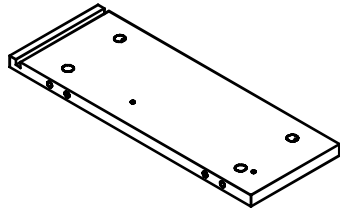

(A1)x1

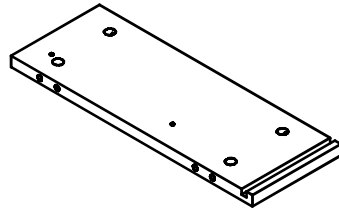

(A2)x1

#### Hardware



(a)x8

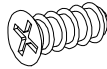

(f)x4

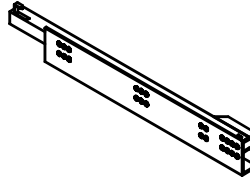

(aa)x1

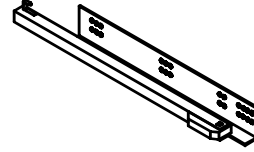

(ab)x1

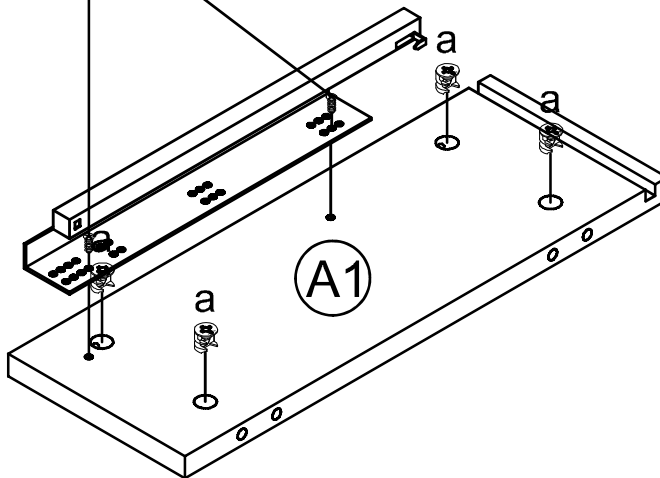
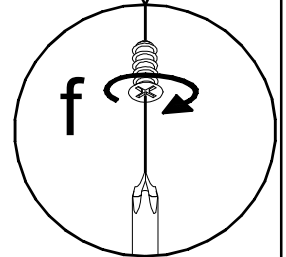
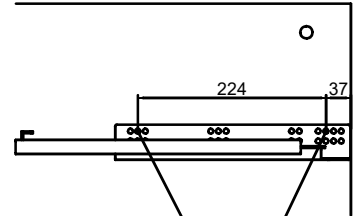
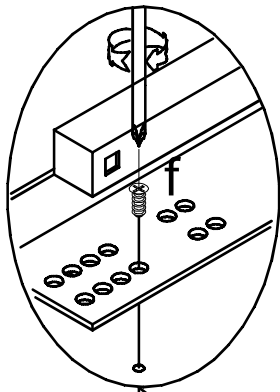

### Step 3

#### Parts

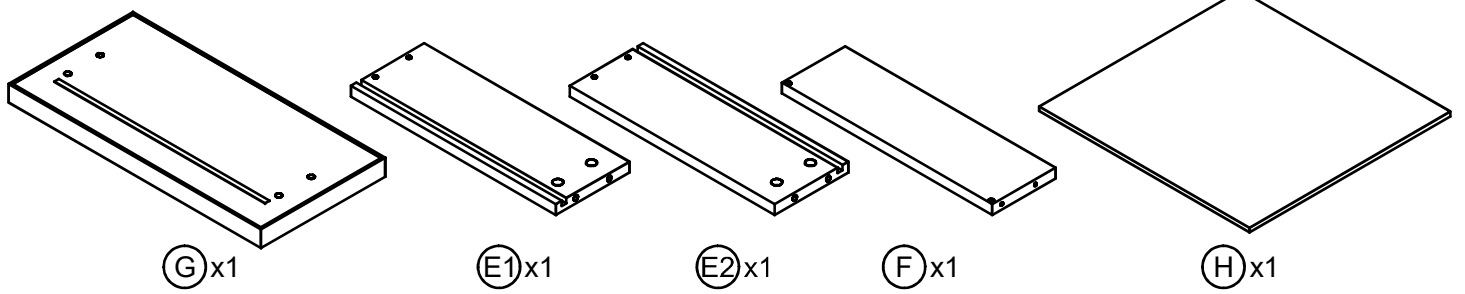

#### Hardware

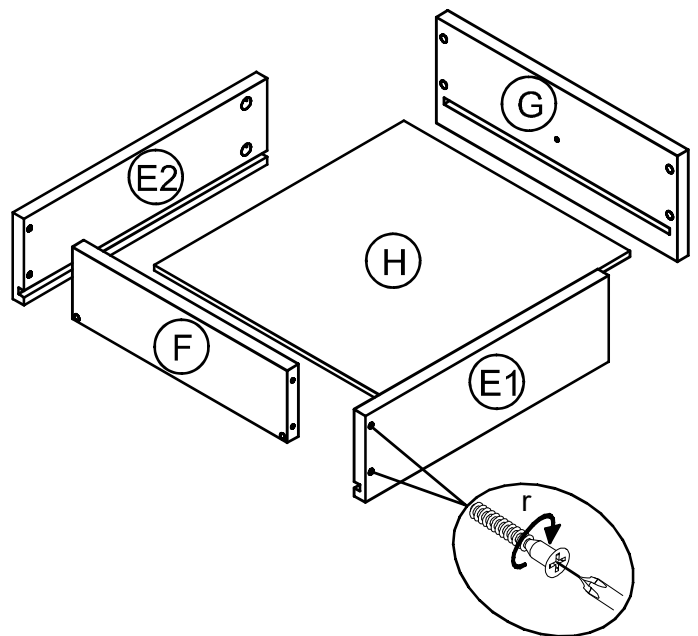
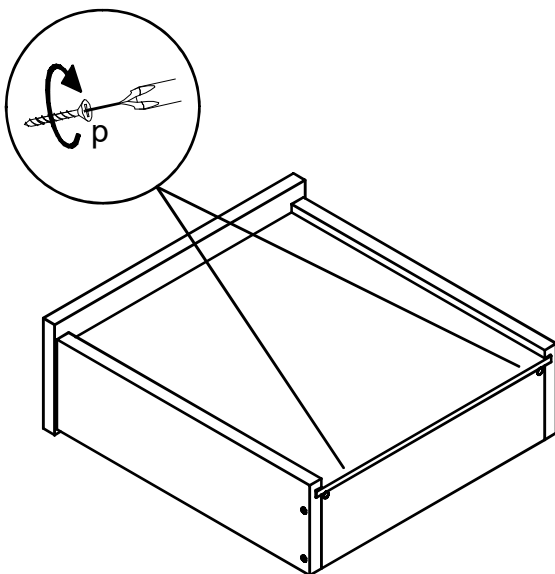
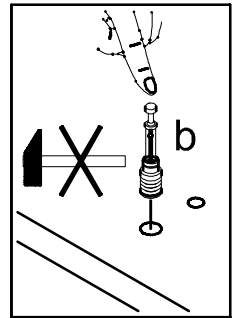
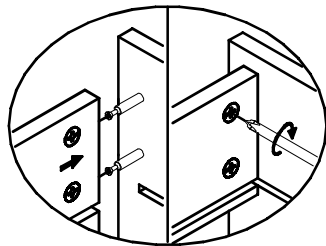
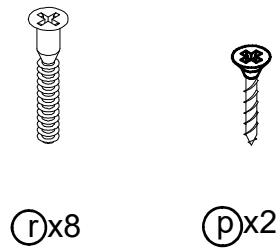

Step 4

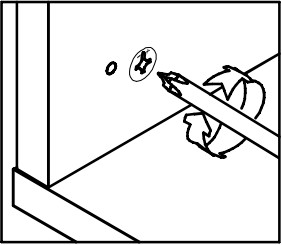
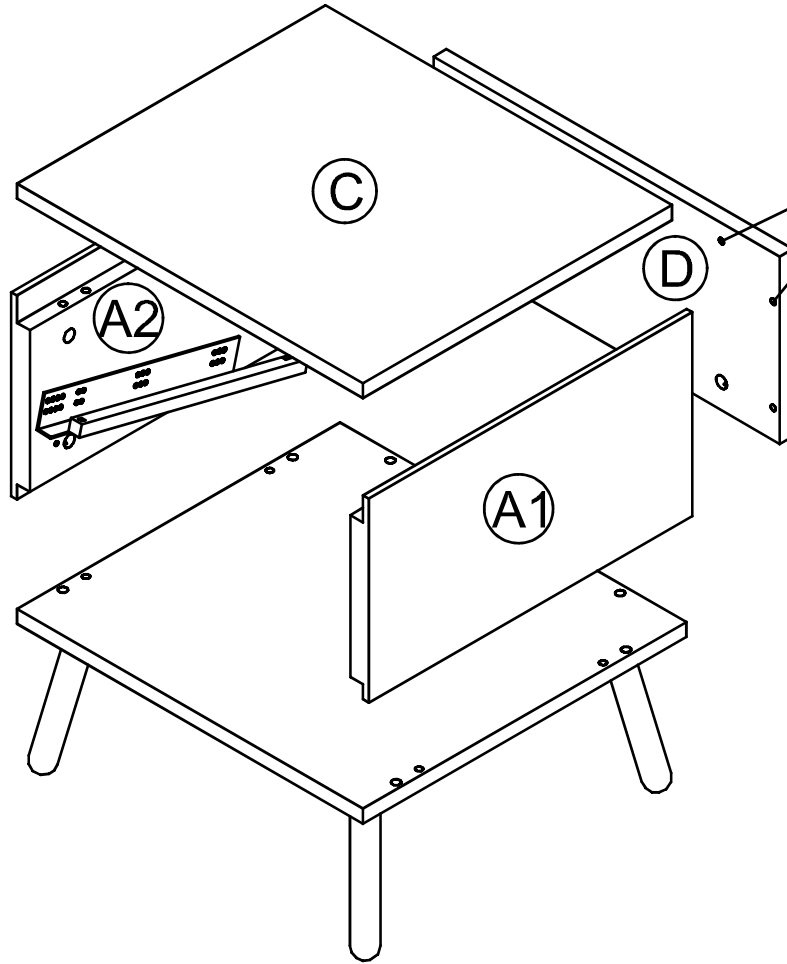
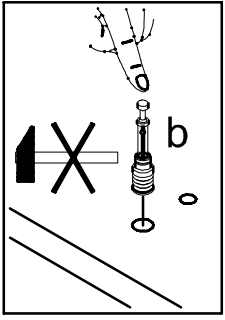

Step 5

